

STANLEY™

ARGON I500 Elegance,



ARGON I500 Panoramic,



INSTALLATION AND OPERATING INSTRUCTIONS

PLEASE RETAIN

This appliance is hot while in operation and retains its heat for a long period of time after use. Children, aged or infirm persons should be supervised at all times and should not be allowed to touch the hot working surfaces while in use or until the appliance has thoroughly cooled.

To ensure safety, satisfaction and reliable service, this appliance must be installed by a suitably qualified and component person.

TABLE OF CONTENTS

	PAGE NO.
1. Stanley Stove Warranty	4
2. Important Operation/ Maintenance Notes	5
3. Commissioning Checklist	6
4. Installation & Operating Instructions	7
5. General	7
6. Electrical Supply	7
7. Location	7
8. Appliance Fireplace Installation	8
9. Building the Fireplace	8
10. Clearance to combustibles	9
11. Gas Pipes & Fittings	10
12. Meters	10
13. Gas Pipe Size	10
14. Gas Connection	10
15. Gas Soundness Testing	10
16. Flue & Chimney Requirement	10
17. Flue Options	12
18. Fuel Bed Arrangement	13
19. Stove Dimensions	15
20. Technical Data	17
21. Countries of use	18
22. Commissioning the Stove	19
23. Pilot Ignition Check	19
24. Main Burner Check	19
25. Pressure Check	19
26. Pairing the Remote Control	19
27. First Time Operation	20
28. Remote Control Operation	20
29. Manual Mode	21
30. Setting Celsius or Fahrenheit	22
31. Setting the Time	20
32. Automatic Operation	23
33. Thermostatic Mode	23
34. Program Mode	23
35. Eco Mode	24
36. Additional Operational Features	25
37. Child Lock	25
38. Countdown Timer	25
39. Rear Burner Operation	25

TABLE OF CONTENTS

	PAGE NO.
40. Wi-Fi Operation	26
41. Maintenance	26
42. CO Alarm	26
43. Battery Replacement	27
44. Servicing	27
45. Wiring Diagram	28
46. Spare Parts	29
47. Service Records	30
48. Fault Finding- General	31
49. Fault Codes - Remote Control	32



STANLEY STOVE WARRANTY

CONDITIONS OF WARRANTY

Your Stanley Stove is guaranteed against any part that fails (under normal operating conditions) as detailed in the following table with timelines specified from the date of installation of the appliance. If the unit is not installed within six months of date of purchase, the warranty will commence six months from the date of purchase.

Warranty Period	Parts Covered (Parts & Labour unless Stated)
Up to 2 Years	<ul style="list-style-type: none">Operational PartsRust (if reported before installation)Aesthetic Damage (provided reported on date of receipt)
Up to 2 Years	<ul style="list-style-type: none">All external castings & enamel finishes (excluding impact damage or damage caused by overfiring). Pictures of damage must be submitted to WS Service Department.

All warranty claims must be reported to the Waterford Stanley Service Department and must be submitted with the product serial number (located on the back of the fire door), date of purchase, proof of purchase (if requested) and details of the specific nature of the problem.

The warranty is given to the original consumer/purchaser only and is non-transferable. The appliance must be installed by a suitable qualified person (RGI Registered in ROI & Gas Safe Registered in NI/UK or equivalent) and installed as per the requirements of the manual. Failure to comply with the Installation Requirements or Building Regulations will void your warranty. Waterford Stanley reserve the right to replace any part due to manufacturing defect that fails within the warranty period under the terms of the warranty. The unit must be used for normal domestic purposes only and in accordance with manufacturer's operation instructions.

LIMITS OF LIABILITY

The warranty does not cover:

- * Bulbs and Batteries.
- * Special, incidental or consequential damages, injury to persons or Property, or any other consequential loss.
- * Any issue caused by negligence, misuse, abuse or circumstances beyond Waterford Stanley's control.
- * Any issue with wear and tear, modification, alteration, or servicing by anyone other than an authorized service engineer.
- * Damage resulting from installation & usage where the appliance has not been installed or used in accordance with the installation or operation instructions or if the installation does not conform to local building, fire & safety regulations.
- * Damage caused to the unit while in transit.
- * Damage caused by storing the unit in a damp, unheated environment.
- * Fading of Paint Finish.
- * Aesthetic damage & missing parts on units purchased off display.
- * Removal & re-installation costs.

Note: Adequate clearance must be maintained around the appliance to ensure the ease of part removal in the possible event of their damage/failure. Waterford Stanley are not responsible for any costs incurred in the removal of items installed in the vicinity of the appliance that have to be moved to facilitate a part replacement.

IMPORTANT OPERATION / MAINTENANCE NOTES

Now that your Stanley Stove is installed and no doubt you are looking forward to the many comforts it will provide, we would like to give you some tips on how to get the best results from your unit.

1. Carefully read all instructions before using this unit.
2. The unit is hot when in use. To avoid burns, do not let bare skin touch hot surfaces.
3. Keep combustible materials, such as furniture, pillows, bedding, papers, clothes and curtains at least 1 metre from the front of the unit.
4. Extreme caution is necessary when any heater is used by or near children or invalids and whenever the unit is left operating and unattended.
5. Do not operate this unit if the glass panel has been broken (or cracked), removed or with firebox access panels open.
6. Do not use the unit for other than its intended use. Do not use outdoors.
7. This appliance must be installed by a RGI Registered Installer (ROI) or a Gas Safe Installer (NI or UK) or equivalent.
8. Before installation, check that the stove is configured for the type of gas that it is to be run on (i.e. Natural Gas or L.P.G.)
9. Only flue approved by Waterford Stanley for this appliance may be used.
10. This stove is a balanced flue product and is room sealed and as such requires no additional ventilation for operation. However an adequate supply of fresh air to maintain temperatures and a comfortable environment is recommended.
11. Do not modify this unit. Use it only as described in this manual. Any other use not recommended by the manufacturer may cause fire, electric shock or injury to persons.
12. **The unit may emit a slight, harmless odour and smoke when first used. This odour and smoke is normal and it is caused by the paint completing the curement process. It is recommended to ventilate the room during the first firing.**
13. Do not strike the glass.
14. Do not attempt to burn rubbish on this appliance.
15. If this appliance is extinguished, on purpose or other, no attempt to relight should be made within 3 minutes.
16. Always clean the glass panel before the fire is ignited. Any finger prints must be removed, as these may burn into the glass and be un-removable.
17. Ensure that the Flue Terminal is not in any way obstructed and is clear of vegetation, i.e. tress, shrubs etc and that no objects are leant against the terminal or guard.
18. Do not use the unit in small rooms when they are occupied by persons not capable of leaving the room on their own, unless constant supervision is provided.
19. Children of less than 3 years should be kept away from the unit unless constantly supervised.
20. Children aged from 3 years and less than 8 years shall only switch on/off the unit provided that it has been placed or installed in its intended normal operating position and they have been given supervision or instruction concerning the use of the unit in a safe way and understand the hazards involved. Children aged from 3 years and less than 8 years shall not plug in, regulate and clean the appliance or perform user maintenance.
21. This unit can be used by children aged from 8 years & above and persons with reduced physical, sensory or mental capabilities or lack of experience & knowledge if they have been given supervision or instruction concerning the use of the unit in a safe way and understand the hazards involved. Children shall not play with the unit. Cleaning and user maintenance shall not be made by children without supervision.

COMMISSIONING CHECK LIST

FLUE SYSTEM	PASS	FAIL
1. Flue Routing in compliance with Guidelines (see Flue Installation)		
2. Waterford Stanley Flue Pipes & Fittings Used.		
3. Flue Terminal positioned correctly & clear of obstructions.		
LOCATION	PASS	FAIL
1. Clearance to combustible materials must be adhered to (see Clearance to Combustible section).		
2. Floor Protection extends 100mm in front, 200mm to sides & 100mm from back.		
3. Clearance must be maintained to allow for maintenance and part replacement.		
GAS CHECK	PASS	FAIL
1. Gas Soundness Test		
2. Inlet Gas Pressure	mbar	
3. Burner Pressure	mbar	
OPERATIONAL CHECK	PASS	FAIL
1. Spillage Test		
2. Remote Control Operation		
3. Pilot Ignition Check		
4. Main Burner Check		
5. Customer advised on use of the Stove		
SAFETY CHECK	PASS	FAIL
1. CO Alarm Fitted		

PRODUCT & INSTALLER INFORMATION

MODEL:	
SERIAL NO:	
GAS TYPE:	
DATE OF PURCHASE:	

INSTALLER:	
CONTACT NO:	
RGI/ GAS SAFE REGISTRATION NO:	
DATE OF INSTALL:	

INSTALLATION & OPERATING INSTRUCTIONS

GENERAL

When installing, operating and maintaining your Stanley Stove, respect basic standards of fire safety. Read these instructions carefully before commencing the installation. Failure to do so may result in damage to persons and property. Consult your local Municipal office and your insurance representative to determine what regulations are in force. Save these instructions for future reference. Please note that it is a legal requirement under the Building Regulations that the installation of the stove is either carried out by a RGI Registered Installer (ROI) or a Gas Safe Installer (NI or UK) or equivalent.

It is important to note that once a type of gas has been specified the stove cannot be run off any other type of gas (i.e. Natural Gas or L.P.G.).

The burner units are not interchangeable between Natural Gas & L.P.G.

Special care must be taken when installing the stove such that the requirements of the Health & Safety at Work Act are met.

Handling

Adequate facilities must be available for loading, unloading and site handling.

Asbestos

This stove contains no asbestos. If there is a possibility of disturbing any asbestos in the course of installation then please seek specialist guidance and use appropriate protective equipment.

Metal Parts

When installing or servicing this stove care should be taken to avoid the possibility of personal injury.

“IMPORTANT WARNING”

This stove must not be installed into a chimney system that serves any other heating appliance.

The complete installation must be done in accordance with current Standards and Local Codes. It should be noted that the requirements and these publications may be superseded during the life of this manual.

Republic of Ireland Installation

Install in accordance with the following:

- * *Building Regulations Part J*
- * *I.S. 813 - Domestic Gas Installations*
- * *I.S. 265 - Part 1 & 2 - Installation of Gas Service Pipes*
- * *I.S. 327 1990 - Domestic Installation using Liquidified Petroleum Gases.*

Northern Ireland & UK Installation

Install in accordance with the following:

- * *The Gas Safety Regulations 1998 (as amended).*
- * *B.S. 5440: Parts 1 & 2, Installation & Maintenance of Flues and Ventilation for Gas Appliances of rated input not exceeding 70kW*
- * *B.S. 5871: Parts 1, 2 & 3, Specification for Installation of Gas Fires, Convector Heaters, Fire/Back Boilers and Decorative Fuel Effect Gas Appliances.*
- * *Building Regulations for England, Scotland, Wales & Northern Ireland.*

Your Stanley Gas stove is supplied with the following items:

- Ceramic Log Set
- Remote Control
- Handle Assembly

ELECTRICAL SUPPLY

All wiring external to the appliance must conform to the current BS 7671 (UK) BS 7462 Safety Document 635: ETC Part 1, Section 5.4.6 and The Electricity at Work Regulations.

If connecting the optional Wi-Fi module (for remote smart phone control), the unit requires a 220V-240V 50L/2 supply connection and any system controls to the mains supply must be through a fused double pole switch having contact separation of at least 3mm with a fuse rated at 3 amp and located in a readily accessible position close to the appliance. Connection should be made through the cable supplied only.

LOCATION

There are several conditions to be considered in selecting a location for your Stanley Stove.

- a. Position in the area to be heated, central locations are usually best.
- b. Allowances for proper clearances to combustibles.
- c. Proposed Routing of Flueing System.
- d. Allowances for proper clearances for maintenance work.

Appliance Fireplace Installation

Determine the position required for the appliance.

Create a gas connection for the appliance in approximately the correct location for the gas controls.

The gas controls are connected to the Burner of the appliance. These controls need to be located in the control access box, so an appropriate position for the access box needs to be determined. The gas valve for the appliance is on a flexible gas hose to allow for flexible location of the access box.

This appliance has fully adjustable legs, these must be set to the desired length before the flue position is finalised. Fine adjustment of the legs is available via the adjustable feet. The leg length can be adjusted from 53-90mm.

Do not make any adjustments to the appliance, except the leg length. The legs must not be adjusted following fitting of the flue.

The appliance is a built in appliance, it is not possible to create an opening and install the appliance into the opening.

The recommended procedure for fitting is to construct a studwork to suit the appliance, it is best to have the appliance on site as a reference when creating the studwork. Create the studwork with the required opening. Install the appliance and then complete the install with plasterboard up to the appliance.

Building the Fireplace

Construct a studwork fireplace to the desired sizes, . Any combustible material used to construct the Fireplace must not be closer than the clearances to combustibles. Fireproof cement Board of minimum thickness 12mm, can be used as a Thermal Break and can be used directly against the Frame Face on the appliance.

Do not use insulation material (or other) to pack the void around or above the appliance. Provide ventilation from the void above the fireplace, 200cm² each side.

Provide a cut-out for the Control Access Door. Control access door available as a spare part see spare parts section.

Installation steps.

- 1 Select a suitable location, taking into account, flueing, clearances to combustibles and gas supply, size of the appliance, etc.
- 2 Have the product nearby for reference measurements when creating the studwork.
- 3 Create a studwork base to the required width and depth.
- 4 Place the product on the base. and fix the product securely.
- 5 Complete the flue installation.

Note

Flue size is 200/130 mm
The Adjustable Legs can be adjusted from 53-90mm

- 6 Complete the gas connection including fitting of the access box to the studwork.
- 7 Test fire the product to ensure it is in full working order
- 8 Complete the studwork overhead the appliance, (metal non combustible stud)
- 9 Place metal trims on the product to ascertain correct sizes for plasterboard.
- 10 Use 12mm fireproof plasterboard to clad the studwork, The plasterboard can be fixed to the appliance as required.
- 11 Fit vents in the plasterboard of adequate cross sectional area,
- 12 Render the plasterboard to complete the installation.

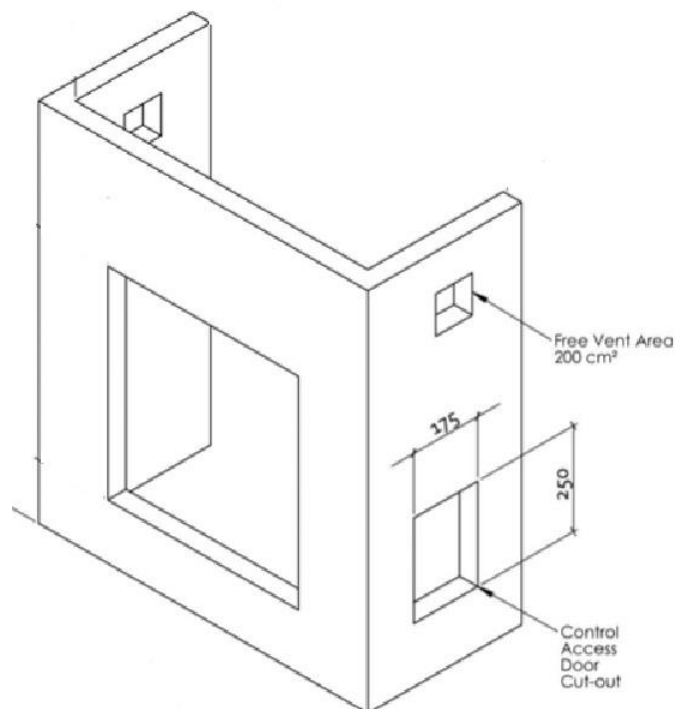
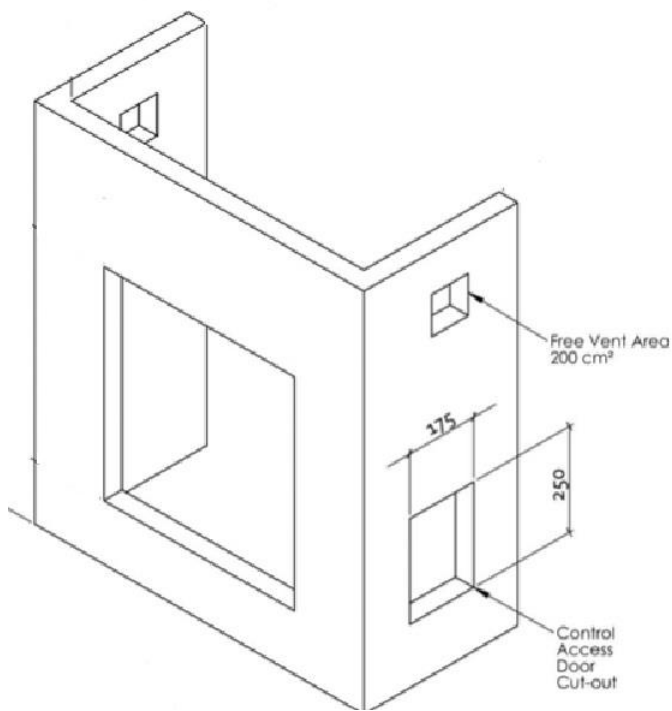

Clearance to combustibles

The appliance should be fitted with a minimum clearance of 150mm from any combustible objects or materials; this includes any combustible materials used for the fireplace construction. This clearance distance can be reduced to 50mm if a Cement Board, of minimum thickness 12mm is used. This Cement Board will act as a Thermal Break.

The clearance distance of the Flue from combustibles must not be less than 75mm. This dimension can be reduced to 25mm as the distance from the underside and the sides of Horizontal Flue runs.

As this is a room sealed appliance and the appliance stands on appropriate legs, a hearth is not required for this appliance. The Fireplace should be ventilated with convection ducts into the room from the fireplace chimney breast with openings giving a total free vent area of 20 cm². A gap of 50mm should be left all around the appliance.

If a shelf is to be fitted above the fireplace opening, a gap of 150mm minimum should be left between the opening and the underside of the shelf.

The brackets supplied may be used for securing the appliance to a rear wall.

GAS PIPES & FITTINGS

Materials used for installation work should be fire resistant and gas tight and should conform to the following or their equivalent.

- * I.S. 238, I.S. 239 and prEN 1057 - Copper tubes.
- * I.S. 265 - Installation of gas service pipes.
- * I.S. 266 - Polyethylene pipes.
- * EN 29453 & I.S.O. 9453 - Soft Solders.
- * B.S. 669 - flexible hoses, fittings & sockets.
- * B.S. 759 - valves, gauges and other safety equipment.
- * B.S. 1387 - Steel tubes.
- * B.S. 6362 - stainless steel tubes.
- * B.S. 1740 - Wrought steel pipes.
- * B.S. 4089 - L.P.G. hoses and assemblies.

METERS

A suitable gas meter must be connected to the service pipe either by a representative of the gas board or by an appointed contractor. If using an existing meter have it checked to ensure that the meter is capable of dealing with the total rate of gas needed

GAS PIPE SIZE

It is important that the correct service pipe size be used for adequate gas supply. This depends on the distance between the supply meter and the appliance relative to the input requirements. The gas supply to the appliance should be terminated near the appliance with an approved safety type service tap.

GAS CONNECTION

The stove has a $\varnothing 8$ mm gas inlet connection located underneath the underside of the burner as shown in Fig 15. The stove is designed to accommodate the routing of the gas feed pipe up through the back of the stove.

Note: An isolation tap must be fitted outside of the stove and positioned to allow for ease of access when required.

WARNING: Before connecting the stove make sure the gas supply pipe is clear of grit and debris as this will cause blockage within the stove control, pilot burner, injectors and pipework. Failure to do so may void product warranty.

WARNING: Only connect to gas type indicated on the rating plate.

GAS SOUNDNESS TESTING

Gas soundness testing should be in accordance with I.S. 813 (I.E.) and B.S. 6891 (U.K.). Correct gas pressure and proper gas supply pipe sizing is important for the successful performance of this stove. Make sure that the plumber or gas supplier checks the gas supply line and gas pressure at installation.

CAUTION: The stove must be isolated from gas supply system during any gas soundness testing at pressures in excess of 50 mbar.

After testing gas supply pipe work, open the isolation valve to the stove and carry out gas soundness testing at normal working pressure 20 mbar for natural gas and 37 mbar for LPG models. With the stove lighting carry out a leak test downstream of control using gas leak detection fluid.

CAUTION: If using a gas leak detection fluid for leak testing DO NOT spray solution onto the control body.

FLUE & CHIMNEY REQUIREMENTS

NOTE: Only flue approved by Waterford Stanley for this appliance may be used.

When installing the flue system the following must be adhered to:

1. Flue terminals should be sited to ensure total clearance of combustion products in accordance with BS5440: Part 1 (latest edition) - see Fig 6.
2. A terminal guard should be fitted to protect against contact for any terminal less than 2 metres above any access from ground level, balcony or flat roof.
3. The flue system must be constructed from the appliance upwards, with all joints being fully locked and sealed using the Waterford Stanley specified parts.
4. Depending on the flue height, a restrictor plate may need to be fitted to the inner spigot (see Fig 5). The following details when a restrictor plate needs to be fitted:

Flue Height	Flue Restrictor Plate
0 -2 metres	None
2 - 4 metres	35mm Restrictor Plate
4 -6 metres	40mm Restrictor Plate
6 - 8 metres	30mm Restrictor Plate
8 - 15 metres	None

Note: House position & wind direction can cause variances in the above guide lines and if the glass starts to blacken, soot forms on the logs or the flame pattern is too small in height, a flue restrictor plate will need to be fitted.

Fig.5



Fig.6

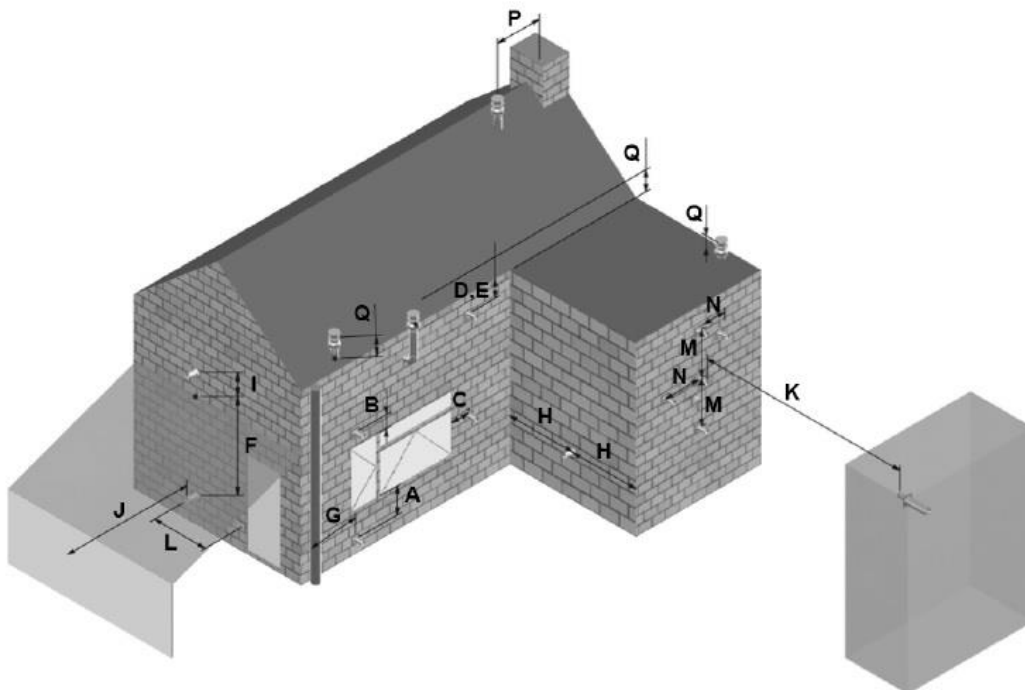

	Terminal Position	Distance (mm)		Terminal Position	Distance (mm)
A*	Directly below an opening, air brick, opening window etc.	600	I	Above ground roof or balcony level	300
B	Above an opening, air brick, opening window etc.	300	J	From a surface facing the terminal	600
C	Adjacent to an opening, air brick, opening window etc.	400	K	From a terminal facing the terminal	600
D	Below gutters, soil pipes or drain pipes	300	L	From an opening in the car port (e.g. door, window into the dwelling)	1200
E	Below eaves	300	M	Vertically from a terminal on the same wall	1500
F	Below balconies of car port roof	600	N	Horizontally from a terminal on the same wall	300
G	From a vertical drain pipe or soil pipe	300	P	From a vertical structure on the roof	600
H	From an internal or external corner	600	Q	Above intersection with roof	150

* In addition, the terminal should not be nearer than 300mm to an opening in the building fabric formed for the purpose of accommodating a built in element such as a window frame.

FLUE OPTIONS

This stove is a balanced flue model for use with concentric fluing which evacuates the products of combustion while also supplying combustion air to the appliance. The flue components are available to order. Each flue component clamps securely to the next using the locking bands provided, where the flue is connected to the appliance the joint must be sealed using a suitable high temperature sealant on both the inner and outer flue spigots to provide an air tight seal.

TOP FLUE - UP & OUT

This type of flue configuration should comply with the following :

- * The horizontal flue run must not exceed the vertical flue rise.
- * Minimum vertical flue rise of 0.5 metres.
- * Maximum vertical flue rise of 5.0 metres.
- * Maximum horizontal flue run of 5.0 metres.

TOP FLUE - VERTICAL

This type of flue configuration should comply with the following :

- * Minimum vertical flue rise of 0.5 metres (from top of unit before bend fitting).
- * Maximum vertical flue rise of 5 metres.
- * Maximum vertical flue rise reduced by 0.25 metres for every 45 degree bend fitted.
- * Length of Vertical flue rise must be twice the length of Horizontal flue run/offset.

STANLEY FLUE FITTINGS

The table across details the list of Waterford Stanley Approved Flue Fittings for this stove.

Part Code	Description
34130610	HORIZONTAL FLUE TERMINATION KIT
34130654	VERTICAL FLUE TERMINATION KIT
37130438	COMBUSTIBLE WALL KIT
34130405	950mm STRAIGHT PIPE
34130404	450mm STRAIGHT PIPE
34130403	250mm STRAIGHT PIPE
34130402	100mm STRAIGHT PIPE
34130441	90 DEGREE BEND
34130421	45 DEGREE BEND
45200172	SLATE ROOF FLASHING KIT
45200173	30-45 DEGREE TILE FLASHING KIT
17100160	Protection basket
37130530	Ventilated fire stop

FUEL BED ARRANGEMENT

NOTE: When arranging the Media into the Firebed, it is important that the Pilot Area & the second thermocouple is kept clear and that no Media enters the Pilot Shield - see Fig 19.

Fig 18 details the various fuel bed media components and they are arranged using the following procedure:

1. Remove the firebox glass panel as described in the Installing the Stove section.
2. Scatter the bags of embers over the top of the burners as shown in Fig 19 keeping the pilot area & second thermocouple clear.

3.5 Fuel Bed Arrangements.

When arranging the Media (Fuel Effect) into the Firebed, it is important that the Pilot area is kept clear and that no Media enters the Pilot shield. The Pilot area includes the pilot shield and the top of the burner to the first slot inside the fence of the pilot shield.

When commissioning or servicing the Appliance Cross Lighting must be checked to ensure smooth lighting of the main burner from the Pilot Flame and smooth lighting of the effect burners from the main Burner



Shown above is the Log set . This will include: 1 Bag of Grey Embers,1 Bag of Black Embers, 11 Logs and a Bag of Glow Strands.

Shown Below are 2 log arrangements, the Bay arrangement is intended for the Bay, Single Front and Corner Models. The Room Divider arrangement is intended for Room Divider and Tunnel models.

After the Embers and Logs have been positioned as per the following arrangements, the Glow Strands can be laid amongst the logs to cause enhanced glow.

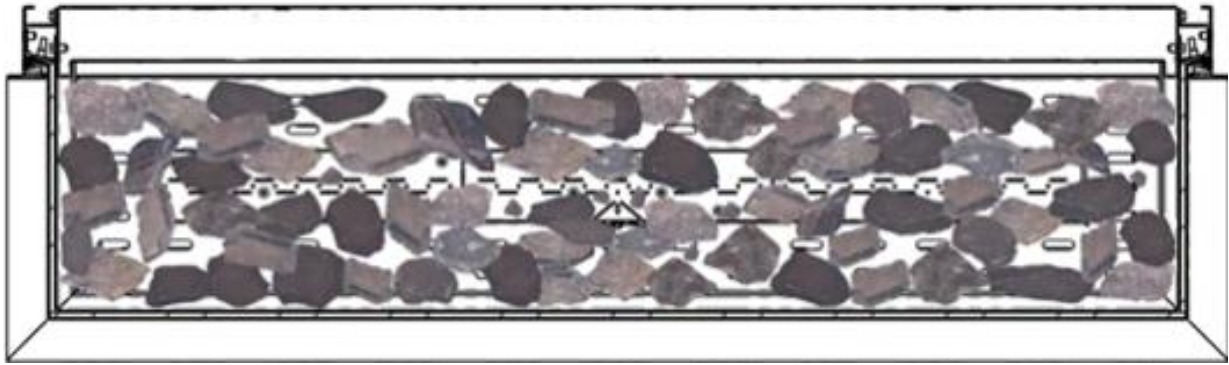

Scatter the Bags of Embers over the top of the burners as shown, keeping the pilot area clear.

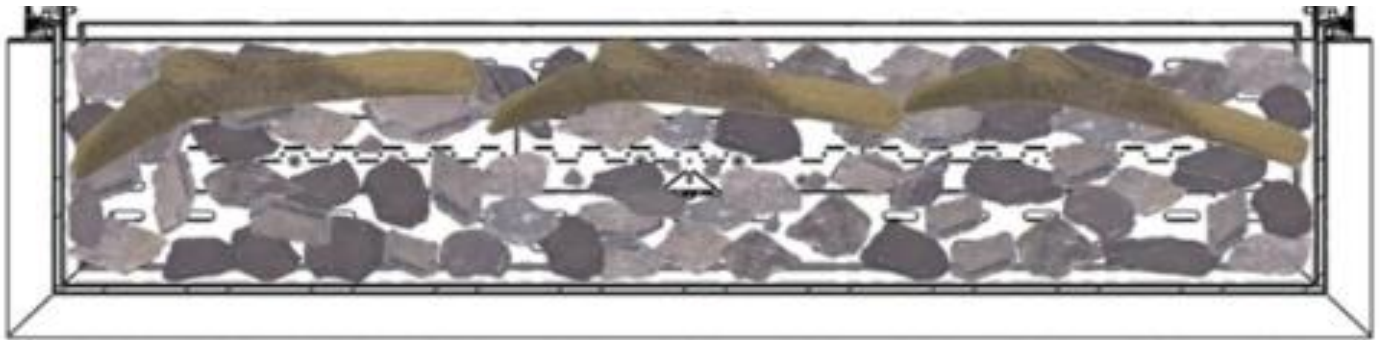

Position the 11 logs as shown.

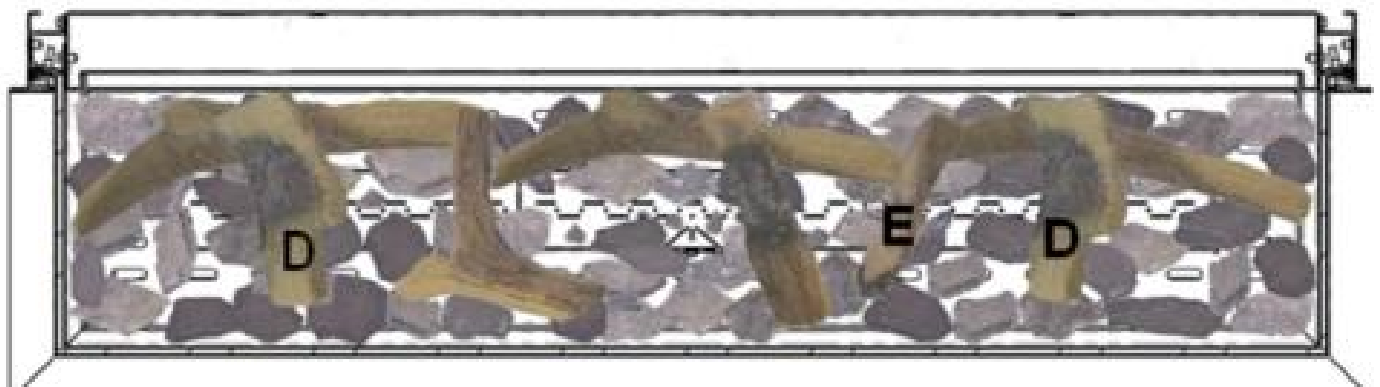
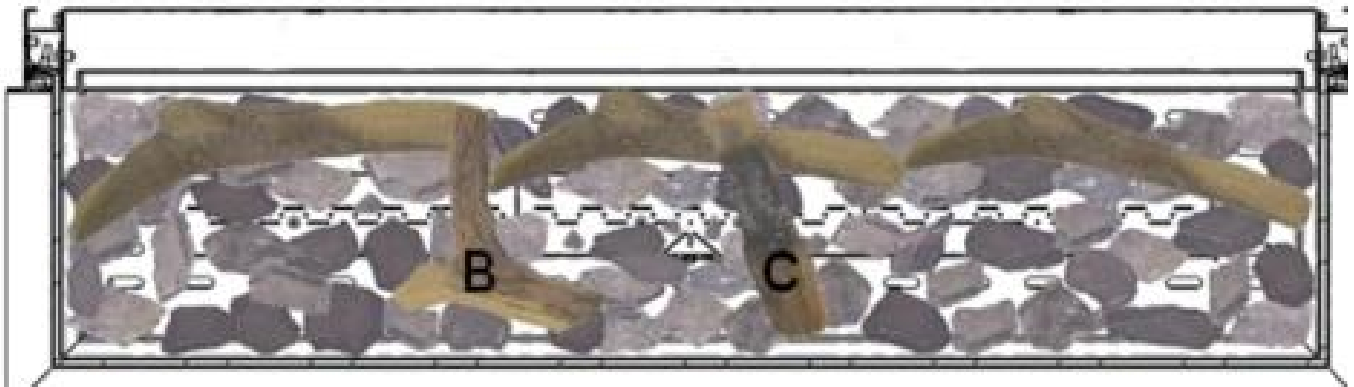

Lay the glow strands amongst the logs in the flames to create an enhanced Glow.

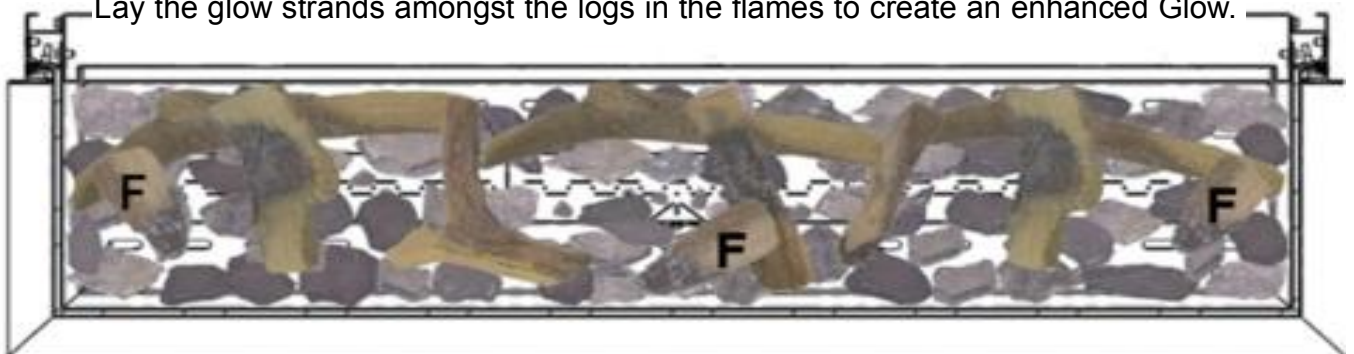

STOVE DIMENSIONS

ARGON I500 Panoramic

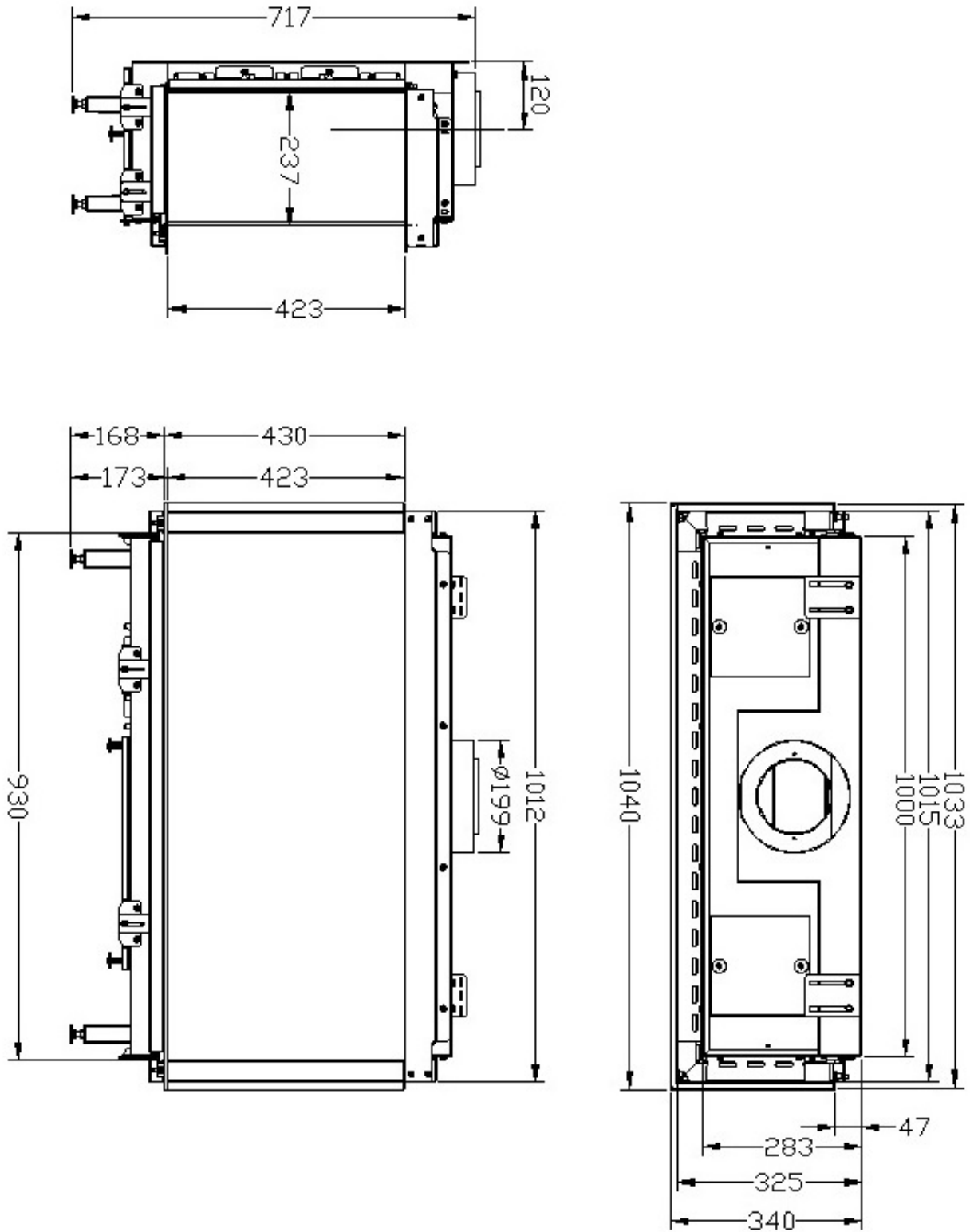

Note: Dimensions stated are in millimetres unless otherwise stated and may be subject to a slight +/- variation.

ARGON I500 Elegance

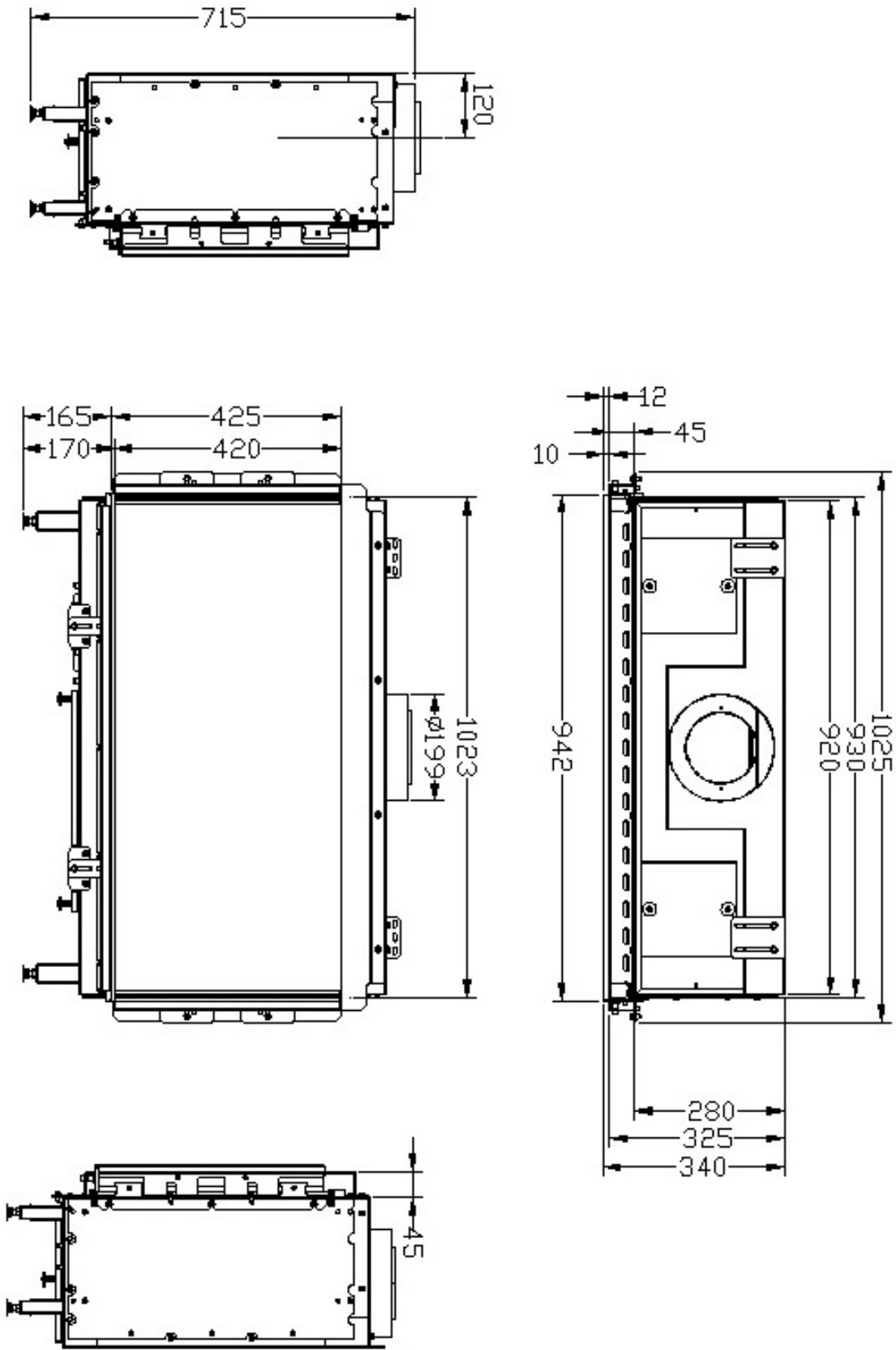

TECHNICAL DATA

Gas type		Nat. Gas				LPG			
		G20 I2H, I2E	G20/G25 I2E+	G25/G25.3 I2L/ I2EK	G20/G25 I2ELL	G30/G31		G31	
						I3B/P(30/50)	I3+	I3P(37,50)	I3P(30)
Supply Pressure	mbar	20	20/25	25	20	30/50	28-30/37	37/50	30
Nominal Heat Input Gross (Hs)	kW	10	10	10	10	11.6	11.6	11.6	10.3
Nominal Heat Input Nett (Hi)	kW	9.0	9.0	9.0	9.0	10.7	10.7	10.7	9.5
Consumption	m ³ /hr	0.938	0.938/1.1	1.1	1.1	0.336	0.336	0.425	0.378
Burner Pressure (hot)	mbar	11.9	11.9\17.1	17.1	18.5	28.3	28.3	35.8	29.2
Injector Marking		280 (x3)				120 (x3)			
Pilot		G30-ZP2-312 (31.2 inj)				G30-ZP2-271 (27.1 inj)			
Efficiency Class		2							
Nox Class		5							
Type		C11/C31							
Gross Weight (Kg)		72							

COUNTRIES OF USE

Country	Natural Gas	L.P.G.
AT - Austria	I2H, G20 at 20 mbar	NOT APPROVED
BE - Belgium	NOT APPROVED	I3+,G31/G31 at 28/37 mbar; I3P(37),G31 at 37 mbar
BG - Bulgaria	I2H, G20 at 20 mbar	NOT APPROVED
CH - Switzerland	I2H, G20 at 20 mbar	I3+,G31/G31 at 28/37 mbar; I3P(37),G31 at 37mbar
CY - Cyprus	I2H, G20 at 20 mbar	I3+,G31/G31 at 28/37 mbar
CZ - Czech Republic	I2H, G20 at 20 mbar	I3+,G31/G31 at 28/37 mbar; I3P(37),G31 at 37 mbar
DE - Germany	NOT APPROVED	NOT APPROVED
DK - Denmark	I2H, G20 at 20 mbar	NOT APPROVED
EE - Estonia	I2H, G20 at 20 mbar	NOT APPROVED
ES - Spain	I2H, G20 at 20 mbar	I3+,G31/G31 at 28/37 mbar; I3P(37),G31 at 37 mbar
FI - Finland	I2H, G20 at 20 mbar	NOT APPROVED
FR - France	I12E+, G20 at 20 mbar	I3+,G31/G31 at 28/37 mbar; I3P(37),G31 at 37 mbar
GB - United Kingdom	I2H, G20 at 20 mbar	I3+,G31/G31 at 28/37 mbar; I3P(37),G31 at 37 mbar
GR - Greece	I2H, G20 at 20 mbar	I3+,G31/G31 at 28/37 mbar; I3P(37),G31 at 37 mbar
HU - Hungary	NOT APPROVED	NOT APPROVED
HR - Croatia	I2H, G20 at 20 mbar	I3P(37),G31 at 37 mbar
IE - Ireland	I2H, G20 at 20 mbar	I3+,G31/G31 at 28/37 mbar; I3P(37),G31 at 37 mbar
IS - Iceland	NOT APPROVED	NOT APPROVED
IT - Italy	I2H, G20 at 20 mbar	I3+,G31/G31 at 28/37 mbar; I3P(37),G31 at 37 mbar
LT - Lithuania	I2H, G20 at 20 mbar	I3+,G31/G31 at 28/37 mbar; I3P(37),G31 at 37 mbar
LU - Luxembourg	I2E, G20 at 20 mbar	NOT APPROVED
LV - Latvia	I2H, G20 at 20 mbar	NOT APPROVED
MT - Malta	NOT APPROVED	NOT APPROVED
NL - The Netherlands	NOT APPROVED	NOT APPROVED
NO - Norway	I2H, G20 at 20 mbar	NOT APPROVED
PL - Poland	I2E, G20 at 20 mbar	I3P(37),G31 at 37 mbar
PT - Portugal	I2H, G20 at 20 mbar	I3+,G31/G31 at 28/37 mbar; I3P(37),G31 at 37 mbar
RO - Romania	I2E, G20 at 20 mbar	NOT APPROVED
SE - Sweden	I2H, G20 at 20 mbar	NOT APPROVED
SL - Slovenia	I2H, G20 at 20 mbar	I3+,G31/G31 at 28/37 mbar; I3P(37),G31 at 37 mbar
SK - Slovakia	I2H, G20 at 20 mbar	I3+,G31/G31 at 28/37 mbar; I3P(37),G31 at 37 mbar
TR - Turkey	I2H, G20 at 20 mbar	I3+,G31/G31 at 28/37 mbar; I3P(37),G31 at 37 mbar

Model	Energy Efficiency Class	Heat Output to Room	Heat Output to Water	Preferred Fuel	Nominal Heat Output	Net Efficiency
Nat gas	A	5.5kW	NA	Natural Gas	5.5kW	81%
LPG	A	5.0kW	NA	LPG	5.0W	83%

COMMISSIONING THE STOVE

The Appliance Commissioning Checklist (see Page 6) must be filled out in conjunction with conducting the following checks:

1. **Pilot Ignition Check**

- A. Ignite the pilot light as described in the Remote Control Operation Section.
- B. Check that the pilot light flame stays light.
- C. Extinguish the pilot light.

2. **Main Burner Check**

- A. Ignite the pilot light as described in the Remote Control Operation Section.
- B. Turn on the main burner as described in the Remote Control Operation Section.
- C. Check that the pilot smoothly cross-lights to the main burner and that the main burner & pilot light stay alight.
- D. Check the operation of the burners at the various flame settings.
- E. Extinguish the stove fully.

3. **Pressure Check**

The stove is preset to the correct heat inputs as listed in the Technical Data Section and the pressure flows **MUST** not be adjusted. The inlet & burner pressures must be checked using the following procedure (see Fig 24):

- A. Turn off the gas valve on the stove.
- B. Turn the screw on the Inlet Pressure Test Point (A) on the gas valve by one turn (DO NOT REMOVE) and connect a manometer.
- C. Check that the measured pressure is as the prescribed supply pressure.
- D. Perform the test when the appliance is burning on full and with only the pilot alight.
- E. If the pressure is low, check the gas supply pipes are the correct size.
- F. If the pressure is too high (more than 5 mbar over) the appliance may be installed, but the gas supply company should be contacted to rectify same.
- G. Retighten the screw on the Inlet Pressure Test Point (A).
- H. Turn the screw on the Burner Pressure test point (B) on the gas valve by one turn (DO NOT REMOVE) and connect a manometer.
- I. Check that the measured pressure is as detailed in the Technical Data Section. The measured value should be within +/- 10% of the prescribed value.
- J. Retighten the screw on the Burner Pressure Test Point (B).
- K. Test the system and gas valve for gas soundness.

Fig.24

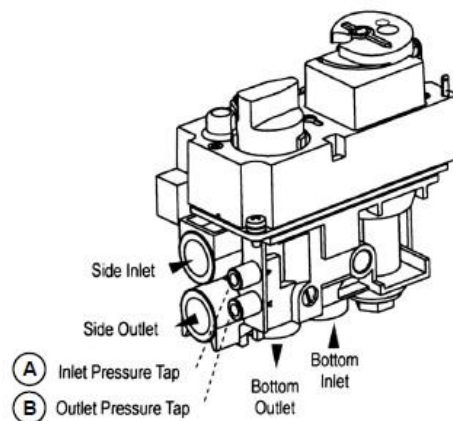

4. **Pairing the Remote Control**

The remote control that comes with the stove should already be paired to the burner. However if it becomes un-paired or you have had a replacement remote control, it can be paired to the burner using the following procedure:

- A. Turn on the Remote Control by pushing & holding the power button (refer to Remote Control Operation Section).
- B. Hold the Reset Button on the side of the gas control box under the burner unit until it beeps twice (see Fig 25).
- C. Press and hold the Down arrow button on the Remote Control until you hear a single beep.
- D. Turn off the Remote Control by pushing the power button.
- E. Turn on the Remote Control by pushing & holding the power button. If the remote has been successful paired, the burner will ignite after approximately ten seconds.

Fig.25



FIRST TIME OPERATION

Before lighting the stove check with the installer that the installation work and commissioning checks described previously have been carried out correctly. Ensure that all packaging, safety stickers & any protective wrapping have been removed and that the glass has been cleaned including all fingerprints on the glass. As part of the stove's commissioning and handover the installer should demonstrate how to operate the stove correctly.

Ensure that the room is adequately ventilated the first time the stove is lit with the windows open. Run the stove at the maximum setting for a few hours so that the paint gets an opportunity to fully cure. During this period it is possible for some fumes and vapours to be given off as the paint completes the curement process.

REMOTE CONTROL OPERATION

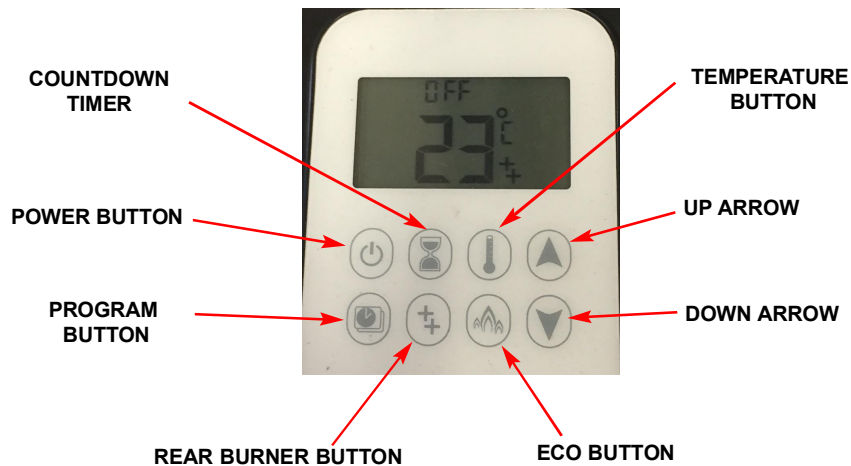
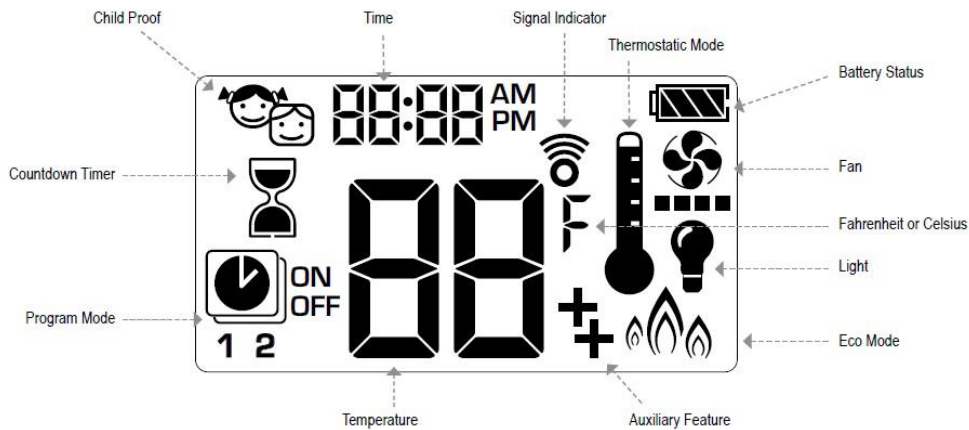

NOTE: If not using the mains adapter, it is recommended that the batteries are replaced in the gas control box at the beginning of the heating season (see Battery Replacement Section). The control box will provide frequent beeps for 3 seconds when the batteries are low. A low battery indicator will be shown on the remote control display when the batteries are low on the remote.

MANUAL MODE

To allow for remote control operation, make sure that the Manual Knob on the gas valve is in the ON (Full counterclockwise position) and the ON/OFF switch is in the I (ON) position - refer to Fig 26.

Press & hold the Power Button, two short beeps are heard and a blinking series of lines appears on the remote display (see Fig 27). This indicates that the start sequence has begun during which the ignitor will spark until the pilot flame lights. When the pilot flame has lit and stabilised, the main burner will ignite & light.

NOTE: If the pilot light does not stay lit after several attempts, turn the main valve knob to OFF and contact your local service engineer.

When the main burner flame has been established, the flame height can be adjusted by (refer to Fig 28):

- * Increase - Press & Hold the Up Arrow Button.
- * Decrease - Press & Hold the Down Arrow Button.

The flame height can also be adjusted to the two preset flame heights by:

- * Low Fire (LO) - Double Click the Down Arrow Button - see Fig 29.
- * High Fire (HI) - Double Click the Up Arrow Button - see Fig 30.

To turn off the stove, press & hold the Power Button until the display shows OFF - see Fig 31.

NOTE: The burner must cool down for 30 seconds before reignition can be attempted

Fig.26

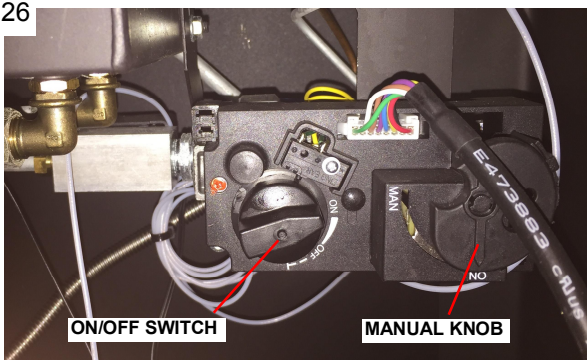

Fig.27



Fig.28



Fig.29



Fig.30



Fig.31



Fig.32



SETTING CELSIUS OR FAHRENHEIT

The remote control comes preset to show the temperature in Fahrenheit and it can be changed to Celsius by pressing & holding the Power Button & Timer Button simultaneously - see Fig 32.

NOTE: Choosing Fahrenheit results in a 12 hour clock being displayed and choosing Celsius results in a 24 hour clock being displayed.

Fig.33

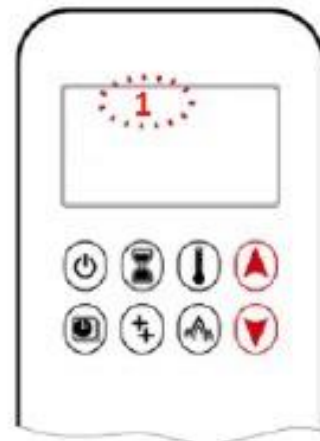

SETTING THE TIME

1. Press the Up Arrow Button & Down Arrow Button simultaneously until the DAY flashes on the display - see Fig 33.
2. Press the Up Arrow Button & Down Arrow Button to select the number that corresponds to the current day (e.g. 1 = Monday, 2 = Tuesday, 3 = Wednesday etc).
3. Press the Up Arrow Button & Down Arrow Button simultaneously until the HOUR flashes on the display - see Fig 34.
4. Press the Up Arrow Button & Down Arrow Button to select the current hour.
5. Press the Up Arrow Button & Down Arrow Button simultaneously until the MINUTES flashes on the display - see Fig 35.
6. Press the Up Arrow Button & Down Arrow Button to select the current minute.
7. To confirm the settings, press and hold the Up Arrow Button & Down Arrow Button simultaneously until the display returns to normal operating mode or the display will return to standby mode if no button is pressed.

Fig.34

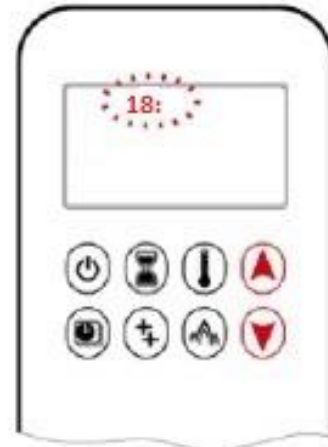

Fig.35



AUTOMATIC OPERATION

The stove has three automatic operation modes:

- A. Thermostatic Mode - The room temperature is compared to the set temperature and the flame height is automatically adjusted until the set temperature is reached.
- B. Program Mode - The stove operates for a set period of time (Two ON/OFF periods per day).
- C. Eco Mode - The Flame Height modulates from High to Low Flame settings. If the room temperature is less than the set temperature, the flame height is maintained at the High setting. If the room temperature is greater than the set temperature, the flame height is maintained at the Low setting. Each cycle will last approximately 20 minutes.

Thermostatic Mode

To activate the Thermostatic Mode, press the Temperature Button. The Temperature Symbol will be displayed, the preset temperature will be displayed briefly followed by the current room temperature (see Fig 36).

To change the preset temperature, press and hold the Temperature Button until the Temperature Symbol is displayed and the preset temperature flashes (see Fig 37). Press the Up Arrow Button & Down Arrow Button to select the desired temperature setting and press & hold the Temperature Button to confirm the setting until the display returns to Thermostatic Mode.

To deactivate the Thermostatic Mode & return to Manual Mode, press the Temperature Button until the Temperature Symbol disappears.

Program Mode

The following procedure should be used when setting the Temperature and Timer Program:

1. To set the temperature, press & hold the Program Button until the Program Mode display flashes ON & the set temperature is displayed. Then the Program Mode display flashes OFF & the set temperature flashes (see Fig 38).
2. Press the Up Arrow Button & Down Arrow Button to select the desired temperature setting.
3. Press the Program Button to confirm the temperature setting.

Fig.36



Fig.37



Fig.38



Fig.39

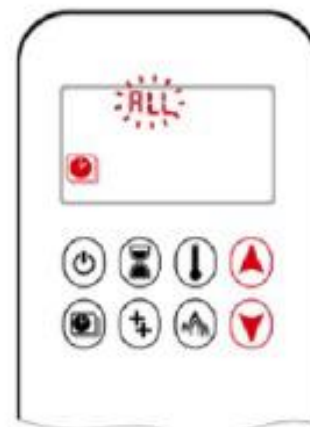

The program mode can be set to operate as follows:

- * ALL - The same programme every day
- * SA:SU - The same programme for weekdays & a different setting for Saturday & Sunday
- * 1,2,3,4,5,6,7. - Different setting for each day.

4. Having confirmed the temperature setting, the Program Mode symbol & ALL will flash on the display - see Fig 39. Press the Up Arrow Button & Down Arrow Button to select the desired setting (e.g. ALL, SA:SU or 1,2,3,4,5,6,7).
5. To confirm press the Program Button.
6. The Program 1 ON setting will be displayed with the hour setting flashing - see Fig 40. Press the Up Arrow Button & Down Arrow Button to select the desired ON hour.
7. To confirm press the Program Button.
8. The minute setting will flash- see Fig 39. Press the Up Arrow Button & Down Arrow Button to select the desired ON minute.
9. To confirm press the Program Button.
10. The Program 1 OFF setting will be displayed with the hour setting flashing. Press the Up Arrow Button & Down Arrow Button to select the desired OFF hour.
11. To confirm press the Program Button.
12. The minute setting will flash and press the Up Arrow Button & Down Arrow Button to select the desired OFF minute.
13. To confirm press the Program Button.
14. The Program 2 ON setting will be displayed with the hour setting flashing & repeat steps 6 to 13 to set the times for Program 2. If not using a time period, set the ON & OFF times to the same time.
15. If you have selected SA:SU or 1,2,3,4,5,6,7, adjust the day setting (1,2,3,4,5,6,7) using the Up Arrow Button & Down Arrow Button and follow steps 6 to 13 to set the times for each day.

To activate the Program Mode, press the Program Button. The Program Mode Symbol will be displayed as shown in Fig 42.

To deactivate the Program Mode & return to Manual Mode, press the Program Button and then press either the Up Arrow Button or Down Arrow Button.

Eco Mode

To activate the Eco Mode, press the Eco Button. The Eco Mode Symbol will be displayed as shown in Fig 43.

To deactivate the Eco Mode & return to Manual Mode, press the Eco Button.

Fig.40

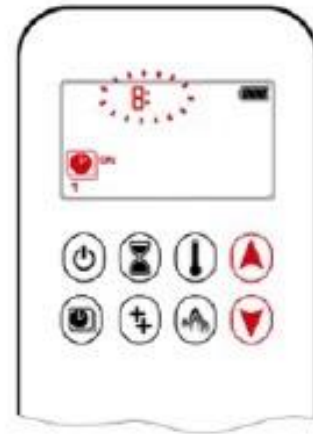

Fig.41

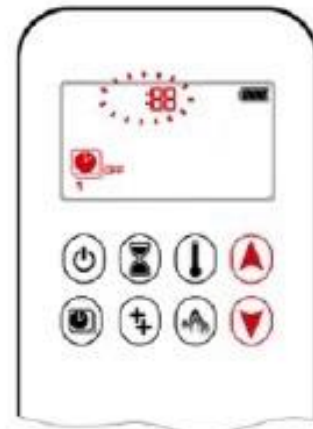

Fig.42



Fig 43



ADDITIONAL OPERATIONAL FEATURES

The remote control Stove has three standard additional operational features:

- A. Child Lock
- B. Countdown Timer
- C. Rear Burner Operation

Child Lock

To activate the Child Lock and disable the remote control (with the exception of the OFF function), press the Power Button and Down Arrow Button simultaneously until the Child Lock Symbol is displayed - see Fig 44.

To deactivate the Child Lock & return to Manual Mode, press the Power Button and Down Arrow Button simultaneously until the Child Lock Symbol disappears.

Countdown Timer

The Countdown Timer allows for the Stove to be operated for a set period (up to maximum of 9 hours & 50 minutes) provided the Stove is set to Manual, Thermostatic or Eco Modes. To set the Countdown Timer:

1. Press & hold the Countdown Timer Button until the Countdown Timer Symbol is displayed and the hour setting flashes- see Fig 45.
2. Press the Up Arrow Button & Down Arrow Button to select the desired hour operating period.
3. Press the Countdown Timer Button to confirm the setting.
4. The minute setting will flash and press the Up Arrow Button & Down Arrow Button to select the desired minute operating period.
5. Press the Countdown Timer Button to confirm the setting. The Countdown Timer Symbol & Timer Clock will be shown on the remote display with the remaining time on the period shown.

To deactivate the Countdown Timer, press & hold the Countdown Timer Button until the Countdown Timer Symbol & Countdown Timer Clock disappears.

Rear Burner Operation

The Rear Burner can be turned On or Off as desired by pressing the Rear Burner Button until the Rear Button Symbol is displayed and the rear burner is ignited (see Fig 46). To deactivate, press the Rear Burner Button until the Rear Button Symbol disappears.

Fig.44



Fig.45

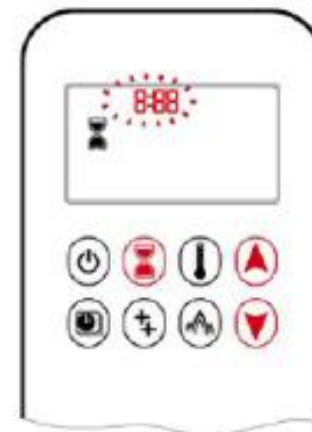

Fig.46



WI-FI OPERATION

The stove can be operated remotely using the *myfire* app by connecting the optional *myfire* Wi-Fi Box (Part Code: B6R-W) and connecting same to a Home Network (Wi-Fi Router). The *myfire* Wi-Fi Box will operate for a short period of time using batteries but if mains power is lost for a period of time, it is recommended to disconnect the Wi-Fi Box from the Gas Valve Control Box. To set-up the *myfire* Wi-Fi Box, use the following procedure:

1. Connect the data cable to the Gas Valve Control Box & *myfire* Wi-Fi Box (refer to Wiring Diagram).
2. Connect the Mains Adaptor to the Gas Control Valve. After 30 seconds the *myfire* Wi-Fi Box goes into Access Point Mode & the green LED flashes - see Fig 47.
3. Download the *myfire* App from Apple App Store or Google Play Store.
4. Start App setup.
5. Choose language, temperature (Celsius or Fahrenheit) and time format (12 or 24 hour).
6. Complete the registration process and Login to the App.
7. Touch the + icon and a message will tell you to go to your smart device Wi-Fi settings.
8. Touch *myfire*_WiFi-Box_<number>.
9. Enter the password "MYFIREPLACE".
10. Select a name for your stove.
11. Type in the name (SSID) of your Wi-Fi router.
12. Type in the password of your Wi-Fi router.
13. Touch "Connect" button.
14. After successful connection a pop-up will tell you to go to your smart device Wi-Fi settings. Touch "OK" if the settings are correct.
15. After confirming fireplace settings touch "Finish".
16. Touch "Start App" to finish the installation & setup process.

NOTE: If any of the Automatic Operation Modes are activated using the App, "APP" will be displayed on the Remote Control.

For further instructions & video on how to set-up the *myfire* App, see <http://myfireapp.com/en/setup/>.

MAINTENANCE

This stove must be inspected and serviced once a year by a qualified/competent Gas Engineer.

Fig.47



1

NOTE: Small impact marks on the enamel finish can be repaired using an appropriate enamel touch up (a touch up bottle is included with the stove packaging) but it should not be used to cover marks greater than $\varnothing 10\text{mm}$ or multiple marks on the same casting/area.

CO ALARM

The fitting of CO Alarms in the same room as the appliance is a compulsory requirement under current Building Regulations. For ROI an additional CO Alarm must be fitted either inside each bedroom or within 5 metres of the bedroom door, refer to Building Regulations Part J. Further guidance on the installation of a carbon monoxide alarm is available in BS EN 50292:2002 and from the alarm manufacturers instructions.

Provision of an alarm must not be considered a substitute for either installing the appliance correctly or ensuring regular servicing and maintenance of the appliance and chimney system.

WARNING:-

If the CO Alarm sounds unexpectedly:-

1. Turn off the stove immediately.
2. Open Doors and windows to ventilate the room and then leave the premises.

WARNING NOTE:

Properly installed, operated and maintained this stove will not emit fumes into the dwelling. In the event of a gas escape or if you can smell gas then the following immediate action should be taken:

- (a) Immediately turn off the gas supply at the meter/emergency control valve.
- (b) Extinguish all sources of ignition.
- (c) Do not smoke.
- (d) Do not operate any electrical light or power switches (ON or OFF).
- (e) Ventilate the building(s) by opening doors & windows.
- (f) Ensure access to the premises can be made.

Please report the incident immediately to Gas Networks Ireland (1850 20 50 50), National Gas Emergency Service Call Centre (0800111999 for UK or 0800002001 for Northern Ireland) or in the case of LPG, the gas supplier whose details can be found on the bulk storage vessel or cylinder.

The gas supply must not be used until remedial action has been taken to correct the defect and the installation has been recommissioned by a competent person.

BATTERY REPLACEMENT

The Gas Valve Control Box requires four AA Batteries which are fitted by removing the front cover and inserting the batteries into the housing as shown in Fig 48. The Remote Control requires two AAA Batteries which are fitted by removing the back cover and inserting the batteries into the housing as shown in Fig 49.

NOTE: It is recommended to use Duracell Ultra Power alkaline batteries. Rechargeable batteries are not to be used. Under normal conditions batteries should last approximately 12 months.

SERVICING

Before carrying out any maintenance, ensure that the Stove is cold and isolate the main gas supply.

ALL SERVICING & REPAIR WORK MUST BE CARRIED OUT BY A QUALIFIED/COMPETENT GAS ENGINEER.

Fig.48

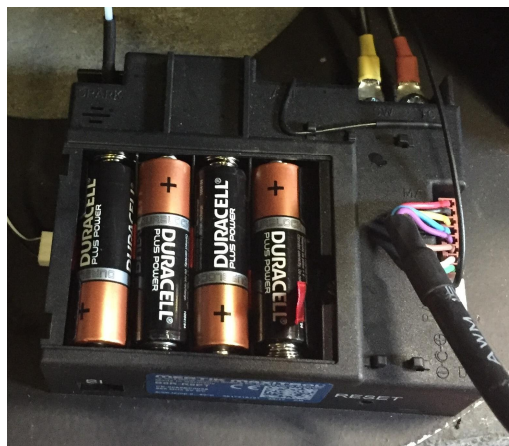

Fig.49



The following is the recommended procedure for servicing the Stove:

1. Remove the firebox glass panel as described in the Installing the Stove section.
2. Carefully remove the Ceramic Logs and Embers.
3. Use a vacuum cleaner and a soft brush to clean the pilot assembly and both injectors. It may be easier to access the Injector by removing the throttle.

NOTE: NEVER MODIFY OR BEND THE THERMOCOUPLE.

4. Turn on the gas supply and check for leaks.
5. Check the operation of the burners & pilot.
6. Clean the Ceramic Logs & Embers external to the building using a soft brush and a vacuum cleaner. Any damaged parts should be replaced.
7. Replace the Ceramic Logs and Embers - see Fuel Bed Arrangement Section.
8. Clean the Firebox Glass Panel & refit same.
9. Refit the Front Fixing Brackets, Front Casting, Bottom Heat Shield & Fire Door.
10. Check the flue system & terminal ensuring that the terminal vent is fully clear.
11. Light the stove and test the pressure settings (see Pressure Check).
12. Test the gas valve and gas system for soundness.
13. Check the safe operation of the Stove.
14. Complete the Service Records Log on the back of the manual.

WIRING DIAGRAM

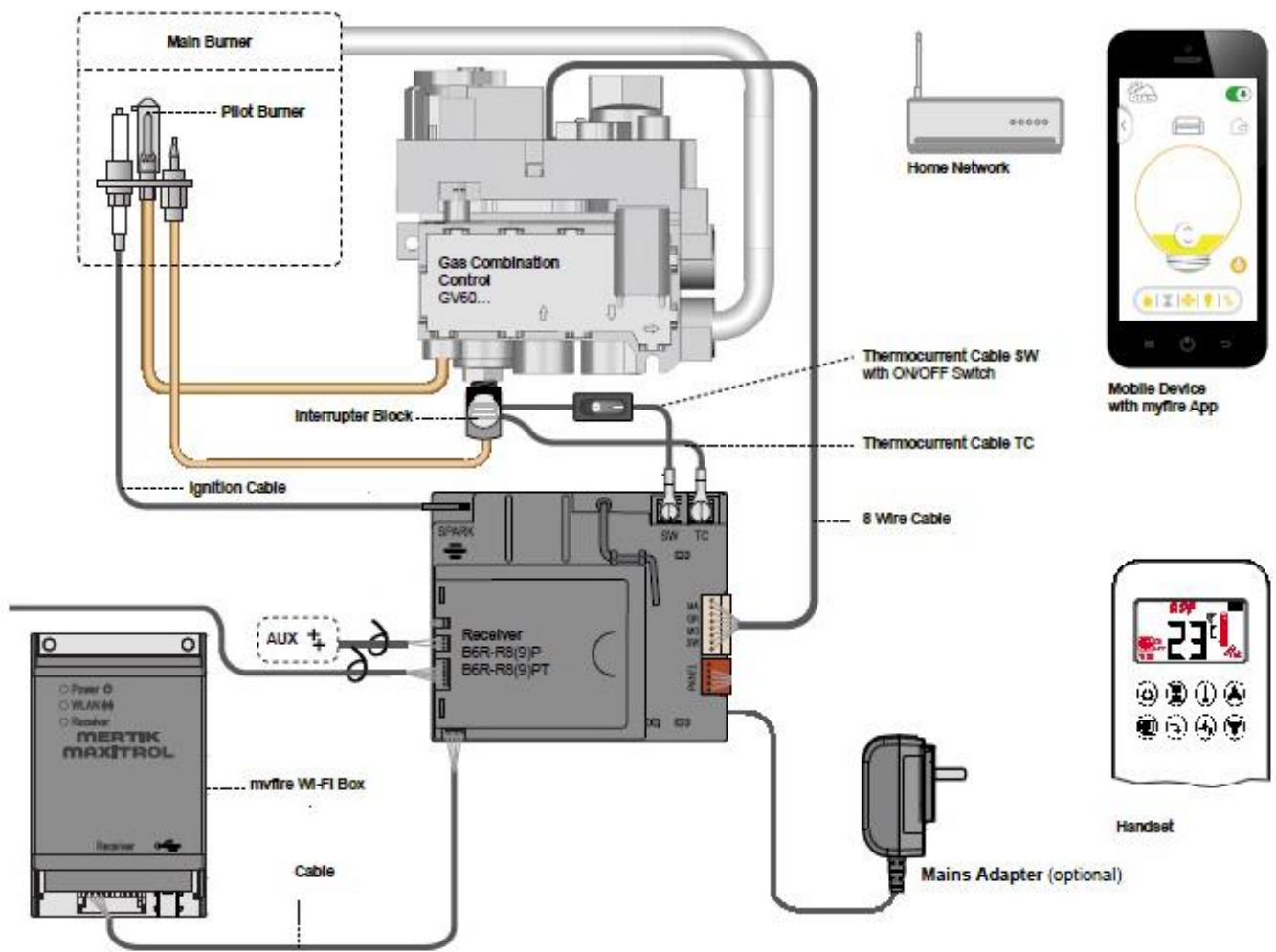

Note: Mains Adapter must be used when Wi-fi Box connected.

SPARE PARTS LIST

Window Panel Main	2B01027
Window Panel Corner (& Bay) Side	2B01127
Ceramic Log Pack	2B01_LOGS
Ember Pack	2B01_EMBR
Pilot Assembly Natural	G30-ZP2-312
Pilot Assembly LPG	G30-ZP2-271
Electrode	G30-SPK1
Electrode Lead	G60-ZKIS1/1500
Thermocouple	CG30182
Injector Natural	EG05177 (x3)
Injector LPG	EG02177 (x3)
Burner Top Assembly	2A01005 (x3)
Complete Burner Assembly Natural	2A01105
Complete Burner Assembly LPG	2A01106
Burner Seal Set	B-SEAL-01
Grate Assembly Bay	2A01054
Gas Valve Assembly Natural	2B_N1_GV60
Gas Valve Assembly LPG	2B_P1_GV60
Latching Solenoid	GV-S60C/12
Receiver unit	G6R-R4AS
Handset	G6R-H4D
Access Door Assembly	2B01_9000



SERVICE RECORDS

1ST SERVICE

Date of Service:.....

Next Service Due:.....

Signed:

RGI/Gas Safe Registration No/Stamp:

2ND SERVICE

Date of Service:.....

Next Service Due:.....

Signed:

RGI/Gas Safe Registration No/Stamp:

3RD SERVICE

Date of Service:.....

Next Service Due:.....

Signed:

RGI/Gas Safe Registration No/Stamp:

4TH SERVICE

Date of Service:.....

Next Service Due:.....

Signed:

RGI/Gas Safe Registration No/Stamp:

5TH SERVICE

Date of Service:.....

Next Service Due:.....

Signed:

RGI/Gas Safe Registration No/Stamp:

6TH SERVICE

Date of Service:.....

Next Service Due:.....

Signed:

RGI/Gas Safe Registration No/Stamp:

7TH SERVICE

Date of Service:.....

Next Service Due:.....

Signed:

RGI/Gas Safe Registration No/Stamp:

8TH SERVICE

Date of Service:.....

Next Service Due:.....

Signed:

RGI/Gas Safe Registration No/Stamp:

FAULT FINDING - GENERAL

ISSUE	POSSIBLE CAUSE	SOLUTION	
Remote Control not working	Remote Control Batteries Low.	Replace Batteries (See Battery Replacement Section)	
	Gas Control Valve Batteries Low.	Replace Batteries (See Battery Replacement Section)	
	Optional Mains Adapter not operating correctly.	Check Mains Adapter.	
	Check link between remote & receiver.	Repair Remote Control (see Pairing Remote Control Section)	
Pilot will not light.	No Gas	Check Gas Supply.	
	Insufficient Gas Pressure	Check Inlet & Outlet Pressures (see Pressure Check Section).	
	Blocked Pilot Injector.	Clear debris from Pilot Injector.	
	ON/OFF Switch in OFF (O) Position.	Push switch to ON Position (see Figure 26).	
	No Ignition Spark.	Check connection between ignition cable & electrode.	
		Check electrode spark gap and ensure electrode is not shorting on burner body.	
Replace electrode.			
	Replace ignition cable.		
Main Burner will not light	Thermocouple & Switch connections reversed.	Check connections to Gas Valve Control Box.	
	Magnet unit not operating properly.	Replace Gas Valve.	
	Short between Interlopers and Switch cable.	Check connection to Interrupter.	
	Insufficient Gas Pressure	Check Inlet & Outlet Pressures (see Pressure Check Section).	
	Resistance in thermocouple circuit too high.	Check thermocouple cable.	
	Not enough heat on thermocouple.	Check position of pilot to thermocouple and intensity of pilot flame.	
	Low voltage from thermocouple.	Replace thermocouple (Hand tight +1/4 turn max)	
	Short because thermocouple is damaged or not centreed.		
	Ignition stops. No reaction to transmitter command.	Press Reset Button on Gas Valve Control Box.	
Main Burner Cuts out after lighting	Too much draft at pilot	Check Installation.	

FAULT CODES - REMOTE CONTROL

FAILURE CODE	DURATION DISPLAYED	SYMPTOM	POSSIBLE CAUSE
F04	4 sec	No Pilot Flame within 30 seconds.	See "Pilot Light will not Light" on Fault Finding Section
F06	4 sec	3 Failed Ignition Sequences within 5 minutes.	
F09	4 sec	Fire is not responding.	Remote Control not synced to Burner. (See Pairing the Remote Control Section)
F40 (Battery Symbol shown)	Permanent	Low Battery on Remote Control	See Battery Replacement Section.
F46	4 sec	Fire is not responding or only responding intermittently.	Bad Connection between Remote Control & Burner. Battery Low on Gas Control Valve (See Battery Replacement Section)

Supplied by
Waterford Stanley Ltd.,
 Unit 401-403, IDA Industrial Estate, Cork Road,
 Waterford, Ireland.
 Tel: (051) 302300 Fax (051) 302315

